

HX318C9SR/4

4GB (4GB 512M x 64-Bit)

DDR3-1866 CL9 240-Pin DIMM



DESCRIPTION

HyperX HX318C9SR/4 is a 512M x 64-bit (4GB) DDR3-1866 CL9 SDRAM (Synchronous DRAM) 1Rx8, memory module, based on eight 512M x 8-bit FBGA components per module. Each module supports Intel® XMP (Extreme Memory Profiles). Each module has been tested to run at DDR3-1866 at a low latency timing of 9-10-11 at 1.5V. The SPDs are programmed to JEDEC standard latency DDR3-1600 timing of 11-11-11 at 1.5V. Each 240-pin DIMM uses gold contact fingers. The JEDEC standard electrical and mechanical specifications are as follows:

XMP TIMING PARAMETERS

- JEDEC: DDR3-1600 CL11-11-11 @1.5V
- XMP Profile #1: DDR3-1866 CL9-10-11 @1.5V
- XMP Profile #2: DDR3-1600 CL9-9-9 @1.5V

SPECIFICATIONS

CL(IDD)	11 cycles
Row Cycle Time (tRCmin)	48.125ns(min.)
Refresh to Active/Refresh Command Time (tRFCmin)	260ns(min.)
Row Active Time (tRASmin)	35ns(min.)
Maximum Operating Power	TBD W*
UL Rating	94 V - 0
Operating Temperature	0° C to +85° C
Storage Temperature	-55° C to +100° C

*Power will vary depending on the SDRAM used.

FEATURES

- JEDEC standard 1.5V (1.425V ~ 1.575V) Power Supply
- VDDQ = 1.5V (1.425V ~ 1.575V)
- 800MHz fCK for 1600Mb/sec/pin
- 8 independent internal banks
- Programmable CAS latency: 11, 10, 9, 8, 7, 6
- Programmable Additive Latency: 0, CL - 2, or CL - 1 clock
- 8-bit pre-fetch
- Burst Length: 8 (interleave without any limit, sequential with starting address "000" only), 4 with tCCD = 4 which does not allow seamless read or write (either on the fly using A12 or MRS)
- Bi-directional Differential Data Strobe
- Internal (self) calibration: Internal self calibration through ZQ pin (RZQ: 240 ohm ± 1%)
- On Die Termination using ODT pin
- Average Refresh Period 7.8us at lower than TCASE 85°C, 3.9us at 85°C < TCASE < 95°C°
- Asynchronous Reset
- Height 1.311" (33.30mm), w/heatsink, single sided component

Continued >>

MODULE WITH HEAT SPREADER

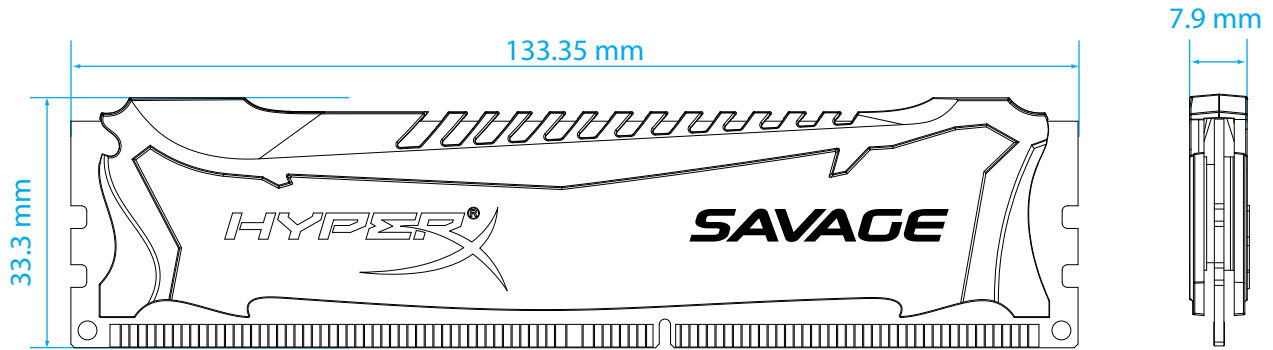

MODULE DIMENSIONS

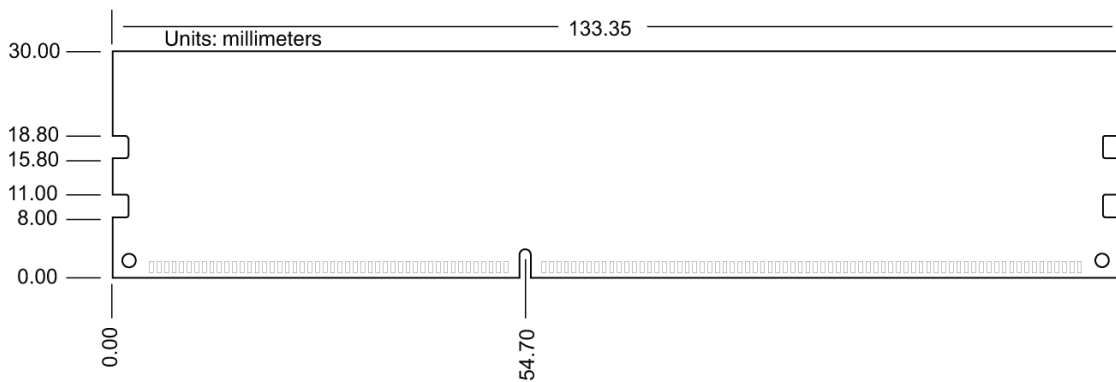
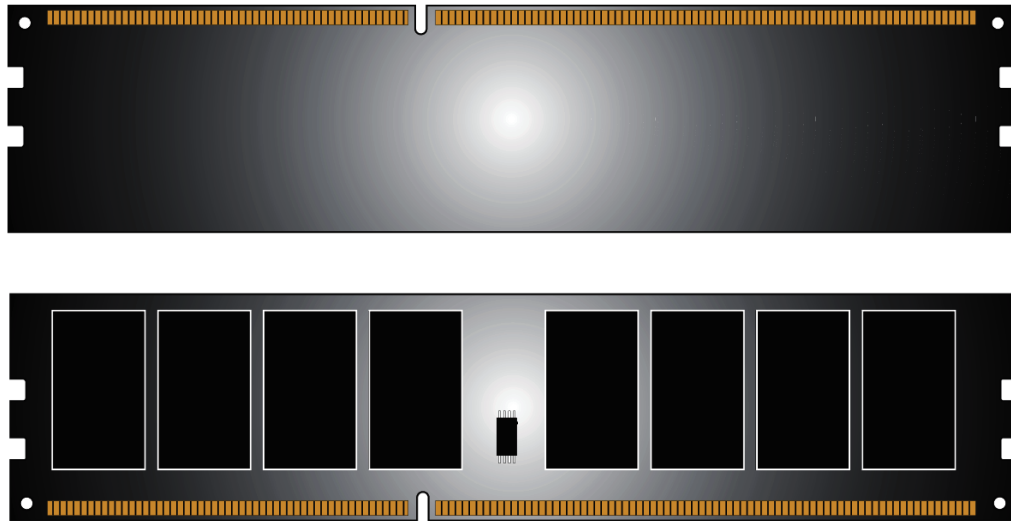

FOR MORE INFORMATION, GO TO WWW.KINGSTON.COM/HYPERX

All Kingston products are tested to meet our published specifications. Some motherboards or system configurations may not operate at the published HyperX memory speeds and timing settings. Kingston does not recommend that any user attempt to run their computers faster than the published speed. Overclocking or modifying your system timing may result in damage to computer components.