

Memory Module Specifications

HX328C12T2K2/8

8GB (4GB 512M x 64-Bit x 2 pcs.)
 DDR3-2800 CL12 240-Pin DIMM Kit



SPECIFICATIONS

CL(IDD)	11 cycles
Row Cycle Time (tRCmin)	48.125ns (min.)
Refresh to Active/Refresh Command Time (tRFCmin)	260ns (min.)
Row Active Time (tRASmin)	35ns (min.)
Maximum Operating Power	2.160 W* (per module)
UL Rating	94 V - 0
Operating Temperature	0° C to 85° C
Storage Temperature	-55° C to +100° C

*Power will vary depending on the SDRAM used.

DESCRIPTION

Kingston's HX328C12T2K2/8 is a kit of two 512M x 64-bit (4GB) DDR3-2800 CL12 SDRAM (Synchronous DRAM), 1Rx8 memory modules, based on eight 512M x 8-bit FBGA components per module. Each module kit supports **Intel XMP®** (Extreme Memory Profiles). Total kit capacity is 8GB. Each module kit has been tested to run at DDR3-2800 at a low latency timing of 12-15-15 at 1.65V. The SPDs are programmed to JEDEC standard latency DDR3-1600 timing of 11-11-11 at 1.5V. Each 240-pin DIMM uses gold contact fingers. The JEDEC standard electrical and mechanical specifications are as follows:

XMP TIMING PARAMETERS

- JEDEC: DDR3-1600 CL11-11-11 @1.5V
- XMP Profile #1: D3-2800 CL12-15-15 @1.65V
- XMP Profile #2: D3-2666 CL11-15-15 @1.65V

FEATURES

- JEDEC standard 1.5V (1.425V ~ 1.575V) Power Supply
- VDDQ = 1.5V (1.425V ~ 1.575V)
- 800MHz fCK for 1600Mb/sec/pin
- 8 independent internal bank
- Programmable CAS Latency: 11, 10, 9, 8, 7, 6
- Programmable Additive Latency: 0, CL - 2, or CL - 1 clock
- 8-bit pre-fetch
- Burst Length: 8 (Interleave without any limit, sequential with starting address "000" only), 4 with tCCD = 4 which does not allow seamless read or write [either on the fly using A12 or MRS]
- Bi-directional Differential Data Strobe
- Internal(self) calibration : Internal self calibration through ZQ pin (RZQ : 240 ohm ± 1%)
- On Die Termination using ODT pin
- Average Refresh Period 7.8us at lower than TCASE 85°C, 3.9us at 85°C < TCASE ≤ 95°C
- Asynchronous Reset
- PCB : Height 2.118" (53.80mm) w/heatsink, single sided component

Continued >>

MODULE WITH HEAT SPREADER

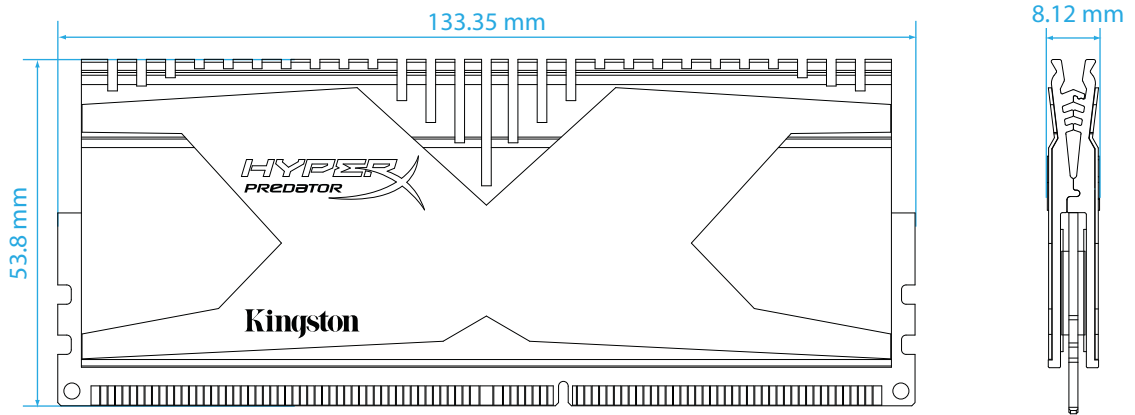

MODULE DIMENSIONS

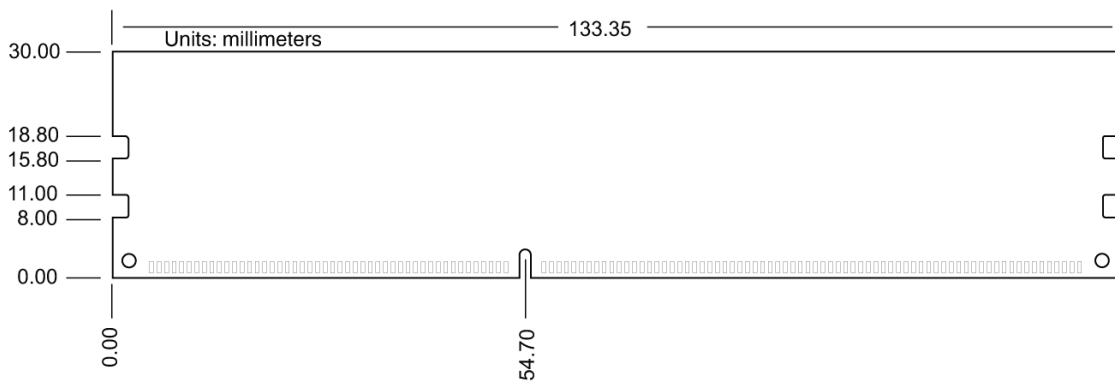
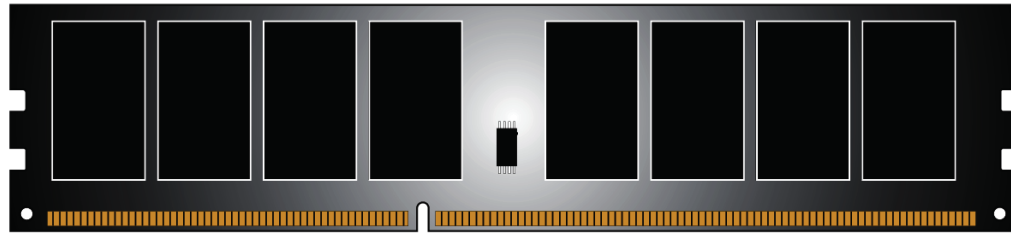
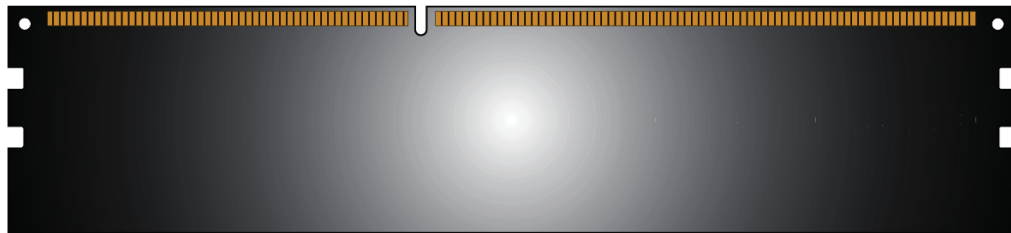

FOR MORE INFORMATION, GO TO WWW.KINGSTON.COM

All Kingston products are tested to meet our published specifications. Some motherboards or system configurations may not operate at the published HyperX memory speeds and timing settings. Kingston does not recommend that any user attempt to run their computers faster than the published speed. Overclocking or modifying your system timing may result in damage to computer components.