

HX430C15SBK2/16

16GB (8GB 1G x 64-Bit x 2 pcs.)
 DDR4-3000 CL15 288-Pin DIMM Kit



DESCRIPTION

HyperX HX430C15SBK2/16 is a kit of two 1G x 64-bit (8GB) DDR4-3000 CL15 SDRAM (Synchronous DRAM) 2Rx8, memory modules, based on sixteen 512M x 8-bit FBGA components per module. Total kit capacity is 16GB. Each module supports Intel® XMP (Extreme Memory Profiles). Each module has been tested to run at DDR4-3000 at a low latency timing of 15-16-16 at 1.35V. The SPDs are programmed to JEDEC standard latency DDR4-2133 timing of 15-15-15 at 1.2V. Each 288-pin DIMM uses gold contact fingers. The JEDEC standard electrical and mechanical specifications are as follows:

XMP TIMING PARAMETERS

- JEDEC: DDR4-2133 CL15-15-15 @1.2V
- XMP Profile #1: DDR4-3000 CL15-16-16 @1.35V
- XMP Profile #2: DDR4-2666 CL14-14-14 @1.35V

SPECIFICATIONS

CL(IDD)	15 cycles
Row Cycle Time (tRCmin)	46.5ns (min.)
Refresh to Active/Refresh Command Time (tRFCmin)	260ns (min.)
Row Active Time (tRASmin)	33ns (min.)
Maximum Operating Power	TBD W*
UL Rating	94 V - 0
Operating Temperature	0° C to +85° C
Storage Temperature	-55° C to +100° C

*Power will vary depending on the SDRAM used.

FEATURES

- Power Supply: VDD = 1.2V Typical
- VDDQ = 1.2V Typical
- VPP - 2.5V Typical
- VDDSPD = 2.25V to 3.6V
- On-Die termination (ODT)
- 16 internal banks; 4 groups of 4 banks each
- Bi-Directional Differential Data Strobe
- 8 bit pre-fetch
- Burst Length (BL) switch on-the-fly BL8 or BC4(Burst Chop)
- Height 1.36" (34.57mm)

Continued >>

MODULE WITH HEAT SPREADER

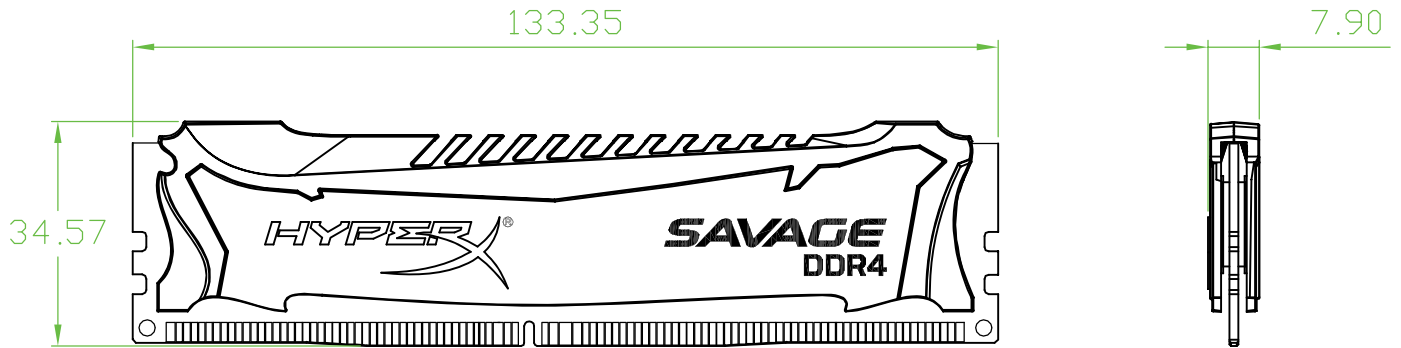

MODULE DIMENSIONS

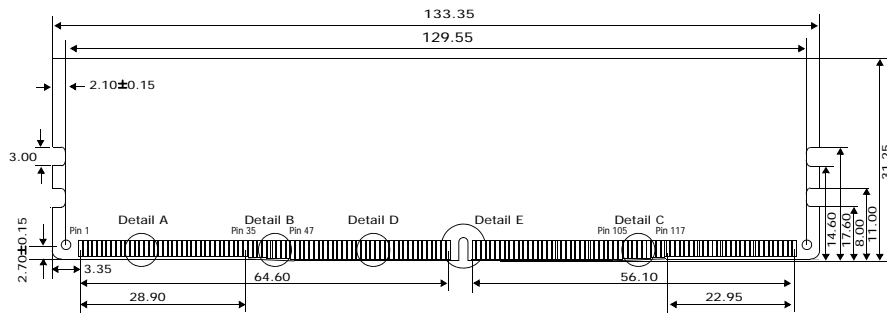
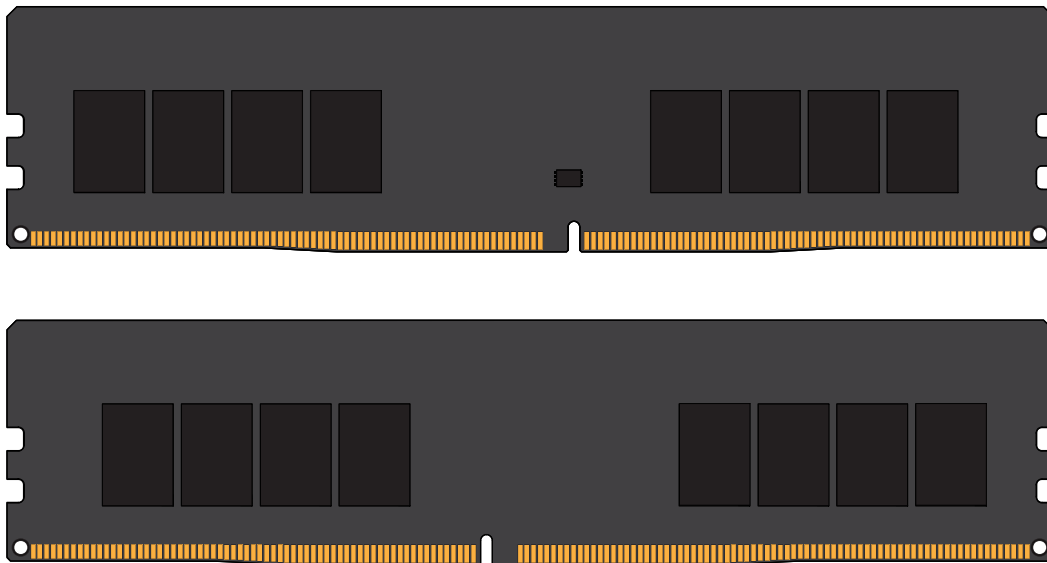

FOR MORE INFORMATION, GO TO HYPERXGAMING.COM

All Kingston products are tested to meet our published specifications. Some motherboards or system configurations may not operate at the published HyperX memory speeds and timing settings. Kingston does not recommend that any user attempt to run their computers faster than the published speed. Overclocking or modifying your system timing may result in damage to computer components.