

## HX434C19FB/16

16GB 2G x 64-Bit

DDR4-3466 CL19 288-Pin DIMM



### DESCRIPTION

HyperX HX434C19FB/16 is a 2G x 64-bit (16GB) DDR4-3466 CL19 SDRAM (Synchronous DRAM) 2Rx8, memory module, based on sixteen 1G x 8-bit FBGA components per module. Each module supports Intel® Extreme Memory Profiles (Intel® XMP) 2.0. Each module has been tested to run at DDR4-3466 at a low latency timing of 19-23-23 at 1.2V. Additional timing parameters are shown in the Plug-N-Play (PnP) Timing Parameters section below. The JEDEC standard electrical and mechanical specifications are as follows:

**Note:** The PnP feature offers a range of speed and timing options to support the widest variety of processors and chipsets. Your maximum speed will be determined by your BIOS.

### JEDEC/XMP TIMING PARAMETERS

- JEDEC/PnP: DDR4-3466 CL19-23-23 @1.2V
- XMP Profile #1: DDR4-3466 CL19-23-23 @1.2V
- XMP Profile #2: DDR4-2933 CL17-19-19 @1.2V

### SPECIFICATIONS

CL(IDD)	19 cycles
Row Cycle Time (tRCmin)	45.75ns(min.)
Refresh to Active/Refresh Command Time (tRFCmin)	350ns(min.)
Row Active Time (tRASmin)	24.234ns(min.)
Maximum Operating Power	TBD W*
UL Rating	94 V - 0
Operating Temperature	0° C to +85° C
Storage Temperature	-55° C to +100° C

\*Power will vary depending on the SDRAM used.

### FEATURES

- Power Supply: VDD = 1.2V Typical
- VDDQ = 1.2V Typical
- VPP = 2.5V Typical
- VDDSPD = 2.2V to 3.6V
- On-Die termination (ODT)
- 16 internal banks; 4 groups of 4 banks each
- Bi-Directional Differential Data Strobe
- 8 bit pre-fetch
- Burst Length (BL) switch on-the-fly BL8 or BC4(Burst Chop)
- Height 1.340" (34.04mm), w/heatsink

Continued >>

### MODULE WITH HEAT SPREADER

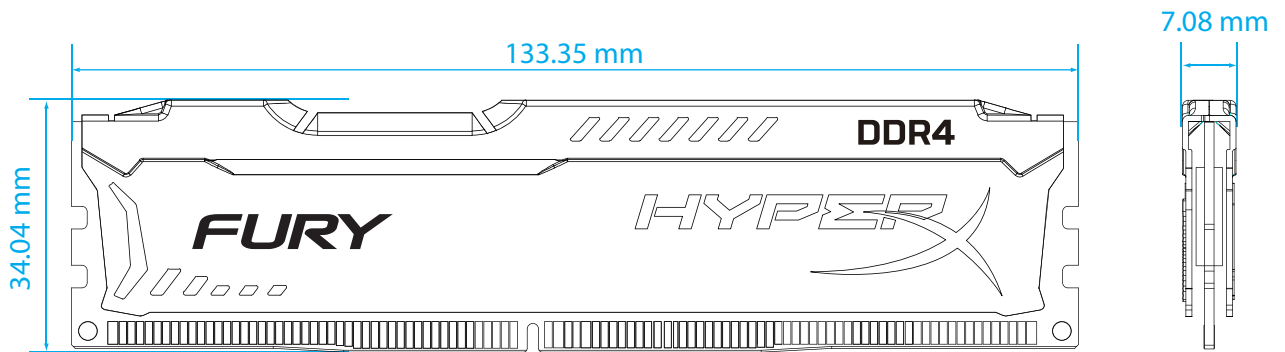

### MODULE DIMENSIONS

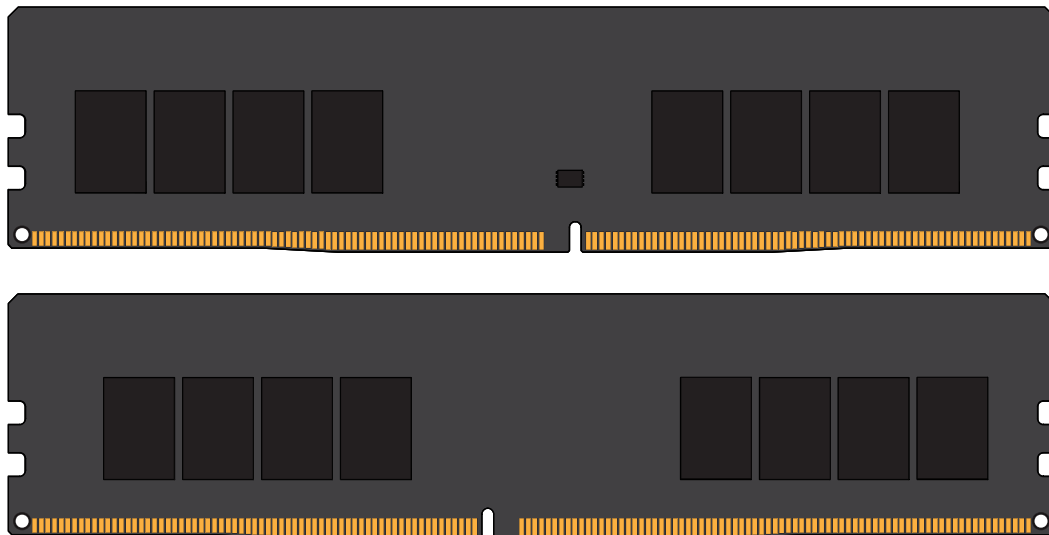

All measurements are in millimeters.  
 (Tolerances on all dimensions are  $\pm 0.12$  unless otherwise specified)

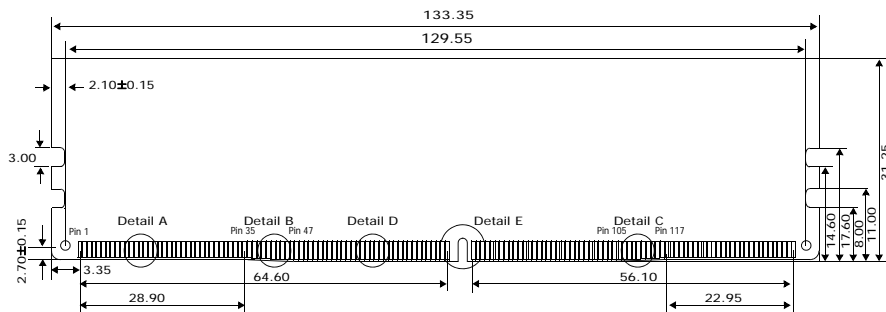

The product images shown are for illustration purposes only and may not be an exact representation of the product. Kingston reserves the right to change any information at anytime without notice.

FOR MORE INFORMATION, GO TO [HYPERXGAMING.COM](http://HYPERXGAMING.COM)

All Kingston products are tested to meet our published specifications. Some motherboards or system configurations may not operate at the published HyperX memory speeds and timing settings. Kingston does not recommend that any user attempt to run their computers faster than the published speed. Overclocking or modifying your system timing may result in damage to computer components.